

> BOX-T

Belt Driven Double Inlet Box Fans



Maico Gulf LLC. certifies that the DYNAIR model BOX-T 7/7 to 630 shown herein are licensed to bear the AMCA Seal. The ratings shown are based on tests and procedures performed in accordance with AMCA Publication 211 and AMCA Publication 311 and comply with the requirements of the AMCA Certified Ratings Program.

GENERAL DESCRIPTION

Direct driven centrifugal cabinet fans with special acoustic lining for improved sound radiation control from 175 to 6,000 CMH airflow range.

The low noise level is due to their plenum, lined with acoustic material that allows a remarkable reduction of noise level, inevitably generated by the fan.

Their main characteristic is the low noise level which makes them ideal for urban environments (apartments, houses, bars, restaurants, gymnasiums, offices) and industrial sites where the noise is a problem.

The low noise level is due to their plenum, lined with acoustic material, that allows a remarkable reduction of noise level, inevitably generated by the fan.

The blower consists of a double inlet double width forward curved centrifugal fan with built-in motor.

CONSTRUCTION

- Profile less cabinet is manufactured in PPGI sheet with removable access panel to allow easy access to fan and motor.
- The blower is fitted using suitable support feet and is completely isolated from the casing by anti-vibration mounts and gaskets.
- Acoustic lining in self-extinguishing techno-polymer.
- Double inlet blower forward curved with direct drive built-in asynchronous motor, single-phase or three-phase, particularly suitable for speed regulation (using the suitable speed regulators shown in this catalogue).
- Flanged inlet and outlet for easy duct work.
- Asynchronous three-phase motors according to international standards IEC 60034, IEC 60072, EMC 2004/108/CE, LVD 2006/95/CE, CE marked, IP 55, class F. Suitable for S1 service (continuous working at constant load).

ACCESSORIES

- Weatherproof protection cover.
- Support feet.
- Outlet terminal with guard.
- Setting shutter.
- Setting shutter with filtering section (standard version with filter in polyester with efficiency 90.1%, class EU4).

BEYOND THE STANDARD PRODUCT

- Version with three-phase double polarity motor (4/6 pole).
- Asynchronous mono-phase motors according to international standards IEC 600034, IEC 60072, EMC 2004/108/CE, LVD 2006/95/CE, CE marked, IP 55, class F. Suitable for S1 service (continuous working at constant load).
- Panels in aluminum.
- Double skin panels (available thickness: 25 or 50 mm) any possible in extruded AL profile
- With pre and bag filter.

DISCHARGE ANGLES

BOX-T

INSPECTION DX	Dx-A1	Dx-A1b	Dx-A2	Dx-A3
INSPECTION SX	Sx-A1	Sx-A1b	Sx-A2	Sx-A3

N.B: Standard discharge angles DX-A1

Air performances measured according to EN ISO 5801 / AMCA 210 standard with air density with 1.2 kg/m³ specific weight. Power supply 220-240V/1Ph/50Hz or 380-420V/3Ph/50Hz.

Lp: Sound pressure level measured in free field conditions, propagation hemispherical, measurement category C in accordance with EN ISO 13349, at the point of maximum efficiency, at a distance of 1.5 meters (for comparative purposes only).
Lw: Sound power level obtained in accordance with EN ISO 3746. Tolerance +/- 3 dB(A).

BOX-T 7-7

FEG 60

ρ: 1.2kg/m³

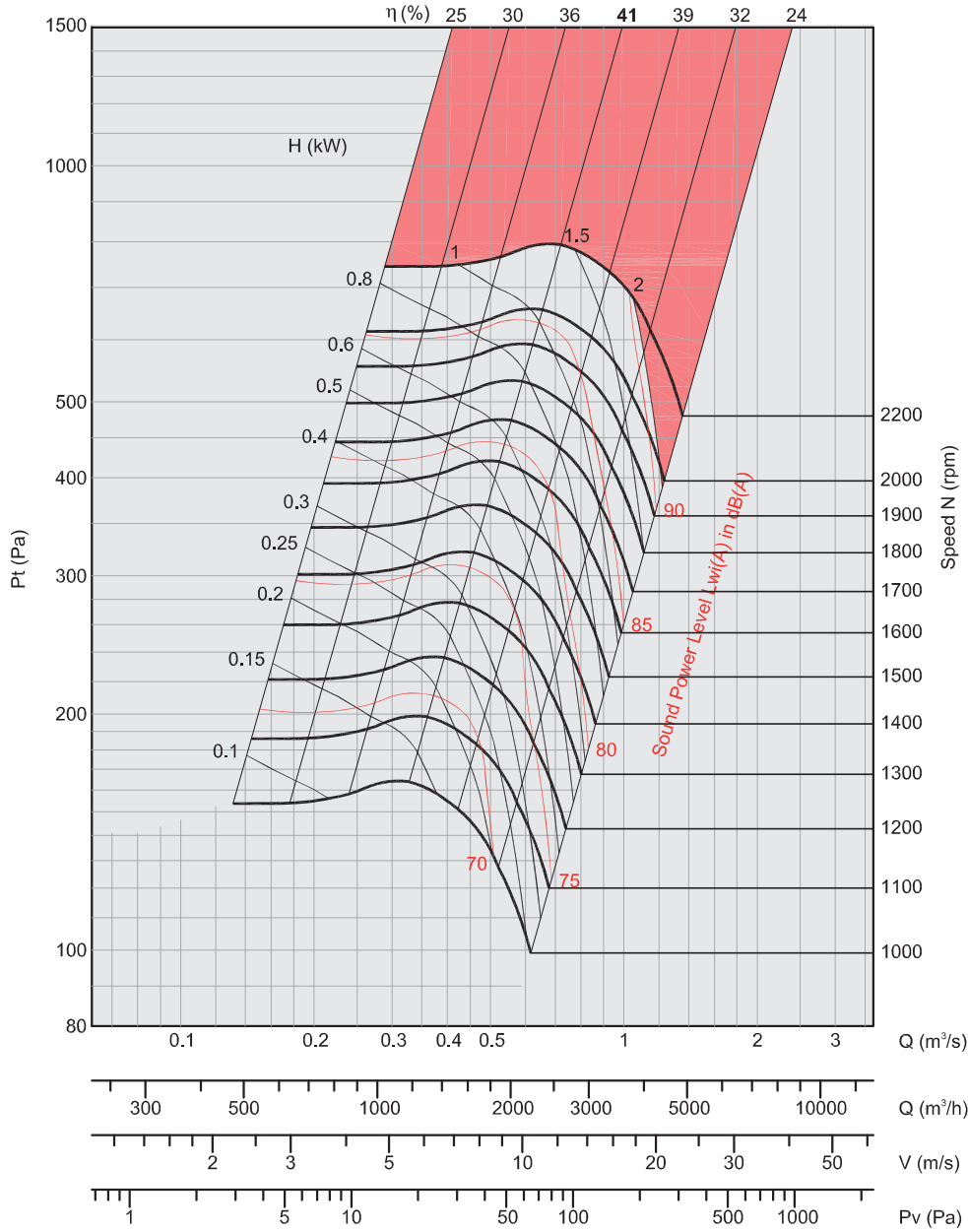

- Performance certified is for installation type B - Free Inlet, Ducted outlet. Power rating kW does not include transmission losses. Performance ratings do not include the effects of appurtenances (accessories).
 - The A-weighted sound ratings shown have been calculated per AMCA International Standard 301. Values shown are for inlet Lw(A) sound power levels for installation Type B: free Inlet, ducted outlet.

$$P_v = (V/1.3)^2$$

Air performances measured according to EN ISO 5801 / AMCA 210 standard with air density with 1.2 kg/m³ specific weight. Power supply 220-240V/1Ph/50Hz or 380-420V/3Ph/50Hz.

Lp: Sound pressure level measured in free field conditions, propagation hemispherical, measurement category C in accordance with EN ISO 13349, at the point of maximum efficiency, at a distance of 1,5 meters (for comparative purposes only).
Lw: Sound power level obtained in accordance with EN ISO 3746. Tolerance +/- 3 dB(A).

BOX-T 9-7

FEG 67

ρ: 1.2kg/m³

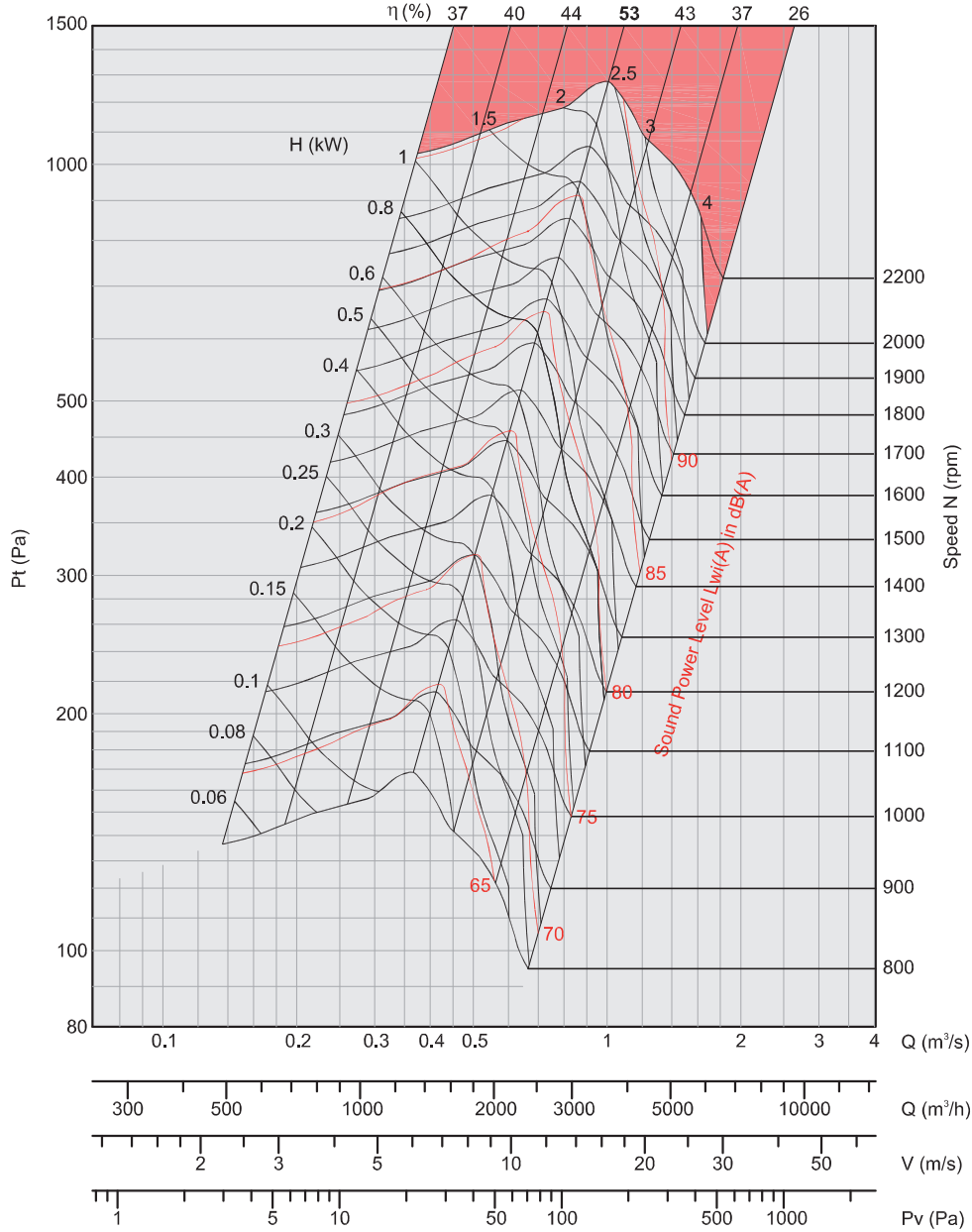

- Performance certified is for installation type B - Free Inlet, Ducted outlet. Power rating kW does not include transmission losses. Performance ratings do not include the effects of appurtenances (accessories).
- The A-weighted sound ratings shown have been calculated per AMCA International Standard 301. Values shown are for inlet Lw(A) sound power levels for installation Type B: free inlet, ducted outlet.

$$P_v = (V/1.3)^2$$

Air performances measured according to EN ISO 5801 / AMCA 210 standard with air density with 1.2 kg/m³ specific weight. Power supply 220-240V/1Ph/50Hz or 380-420V/3Ph/50Hz.

Lp: Sound pressure level measured in free field conditions, propagation hemispherical, measurement category C in accordance with EN ISO 13349, at the point of maximum efficiency, at a distance of 1,5 meters (for comparative purposes only).
Lw: Sound power level obtained in accordance with EN ISO 3746. Tolerance +/- 3 dB(A).

BOX-T 9-9

FEG 63

ρ: 1.2kg/m³

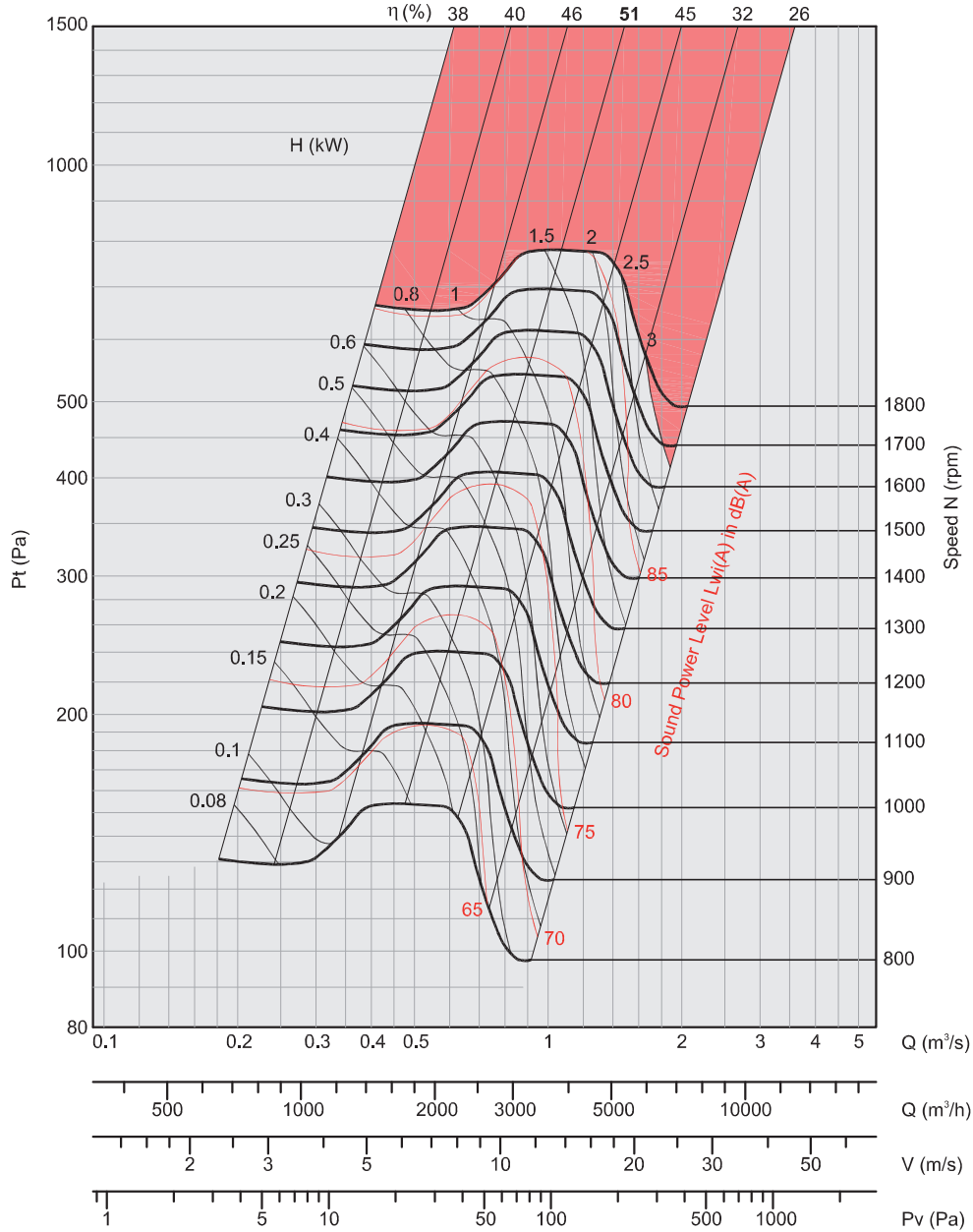

- Performance certified is for installation type B - Free inlet, Ducted outlet. Power rating kW does not include transmission losses. Performance ratings do not include the effects of appurtenances (accessories).
- The A-weighted sound ratings shown have been calculated per AMCA International Standard 301. Values shown are for inlet Lw(A) sound power levels for installation Type B: free inlet, ducted outlet.

$$P_v = (V/1.3)^2$$

Air performances measured according to EN ISO 5801 / AMCA 210 standard with air density with 1.2 kg/m³ specific weight. Power supply 220-240V/1Ph/50Hz or 380-420V/3Ph/50Hz.

L_p: Sound pressure level measured in free field conditions, propagation hemispherical, measurement category C in accordance with EN ISO 13349, at the point of maximum efficiency, at a distance of 1,5 meters (for comparative purposes only).
L_w: Sound power level obtained in accordance with EN ISO 3746. Tolerance +/- 3 dB(A).

BOX-T 10-8

FEG 60

ρ: 1.2kg/m³

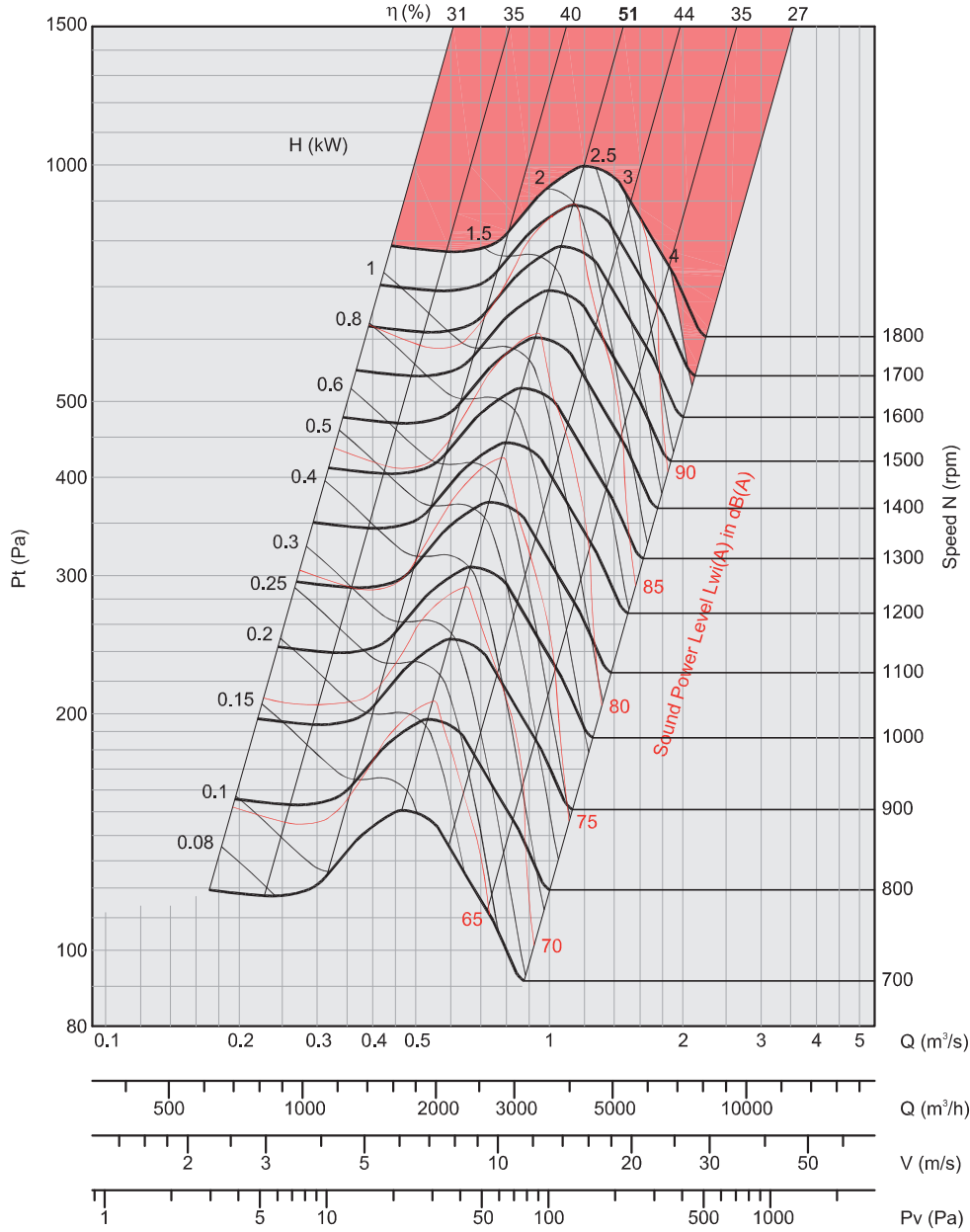

- Performance certified is for installation type B - Free inlet, Ducted outlet. Power rating kW does not include transmission losses. Performance ratings do not include the effects of appurtenances (accessories).
 - The A-weighted sound ratings shown have been calculated per AMCA International Standard 301. Values shown are for inlet L_wA sound power levels for installation Type B: free inlet, ducted outlet.

$$P_v = (V/1.3)^2$$

Air performances measured according to EN ISO 5801 / AMCA 210 standard with air density with 1.2 kg/m³ specific weight. Power supply 220-240V/1Ph/50Hz or 380-420V/3Ph/50Hz.

Lp: Sound pressure level measured in free field conditions, propagation hemispherical, measurement category C in accordance with EN ISO 13349, at the point of maximum efficiency, at a distance of 1.5 meters (for comparative purposes only).
Lw: Sound power level obtained in accordance with EN ISO 3746. Tolerance +/- 3 dB(A).

BOX-T 10-10

FEG 56

$\rho: 1.2\text{kg/m}^3$

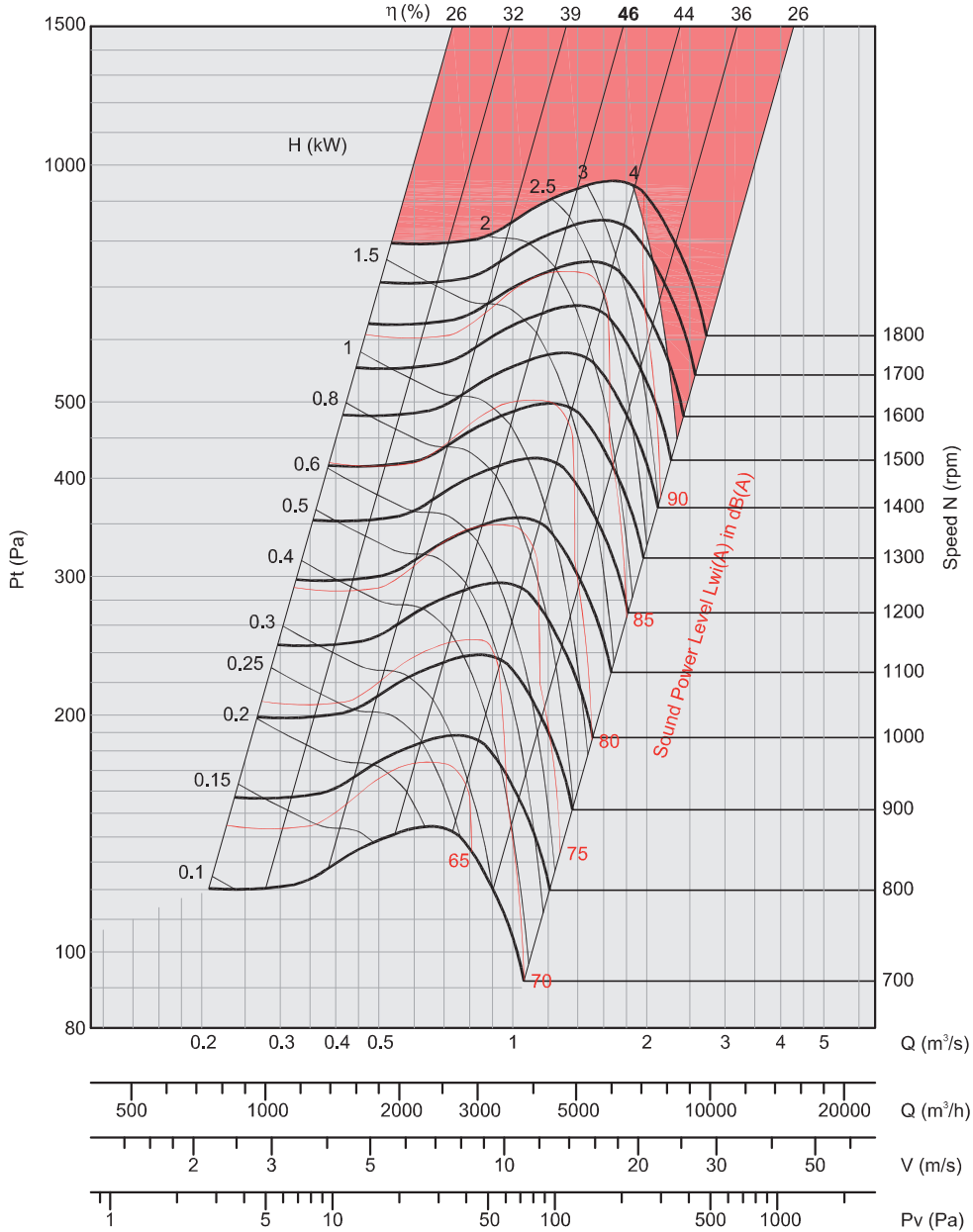

- Performance certified is for installation type B - Free inlet, Ducted outlet. Power rating kW does not include transmission losses. Performance ratings do not include the effects of appurtenances (accessories).
 - The A-weighted sound ratings shown have been calculated per AMCA International Standard 301. Values shown are for inlet LwA sound power levels for installation Type B: free inlet, ducted outlet.

$$P_v = (V/1.3)^2$$

Air performances measured according to EN ISO 5801 / AMCA 210 standard with air density with 1.2 kg/m³ specific weight. Power supply 220-240V/1Ph/50Hz or 380-420V/3Ph/50Hz.

L_p: Sound pressure level measured in free field conditions, propagation hemispherical, measurement category C in accordance with EN ISO 13349, at the point of maximum efficiency, at a distance of 1.5 meters (for comparative purposes only).
L_w: Sound power level obtained in accordance with EN ISO 3746. Tolerance +/- 3 dB(A).

BOX-T 12-9

FEG 63

ρ: 1.2kg/m³

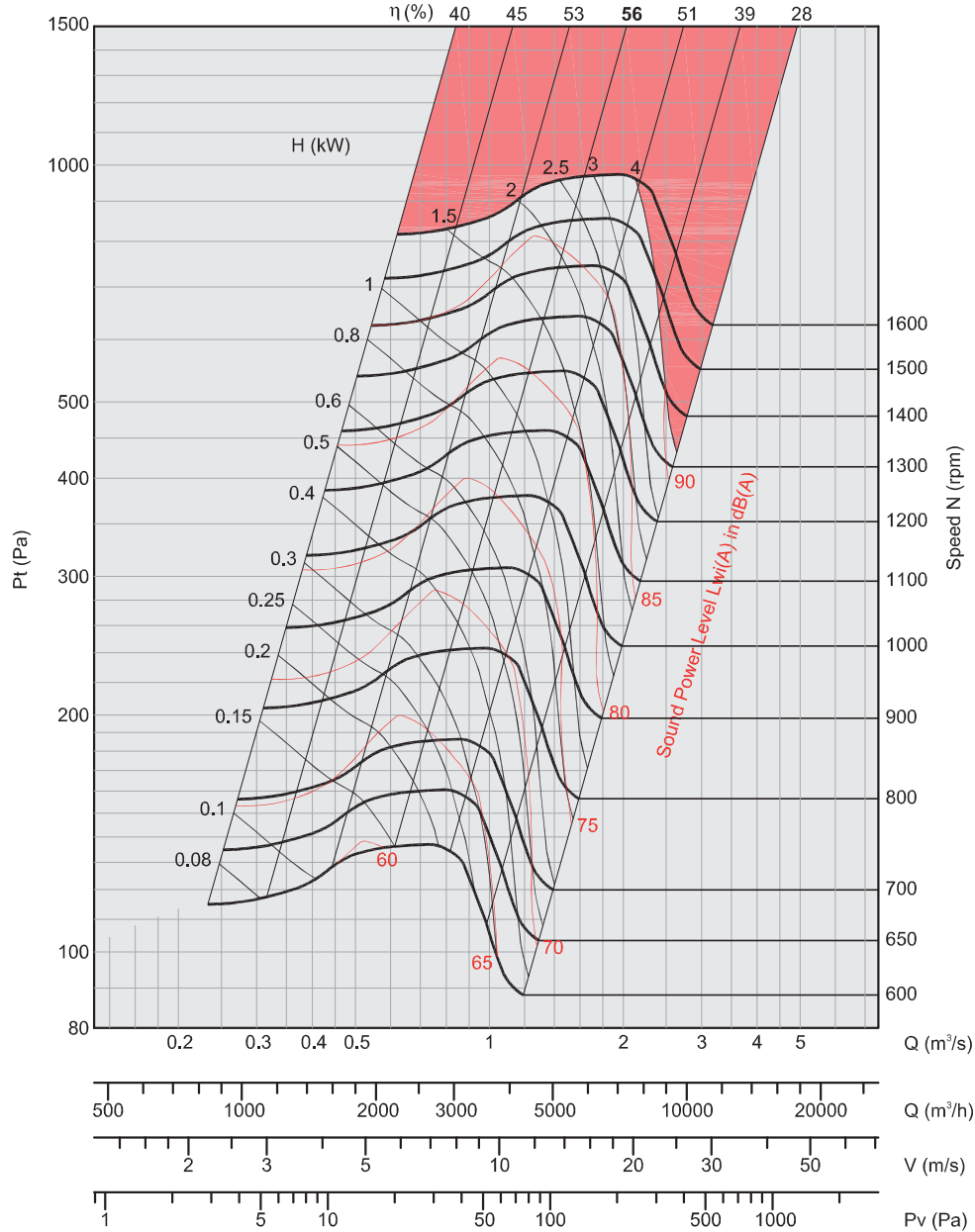

- Performance certified is for installation type B - Free inlet, Ducted outlet. Power rating kW does not include transmission losses. Performance ratings do not include the effects of appurtenances (accessories).
 - The A-weighted sound ratings shown have been calculated per AMCA International Standard 301. Values shown are for inlet LwA sound power levels for installation Type B: free inlet, ducted outlet.

$$P_v = (V/1.3)^2$$

Air performances measured according to EN ISO 5801 / AMCA 210 standard with air density with 1.2 kg/m³ specific weight. Power supply 220-240V/1Ph/50Hz or 380-420V/3Ph/50Hz.

Lp: Sound pressure level measured in free field conditions, propagation hemispherical, measurement category C in accordance with EN ISO 13349, at the point of maximum efficiency, at a distance of 1.5 meters (for comparative purposes only).
Lw: Sound power level obtained in accordance with EN ISO 3746. Tolerance +/- 3 dB(A).

BOX-T 12-12

FEG 60

ρ: 1.2kg/m³

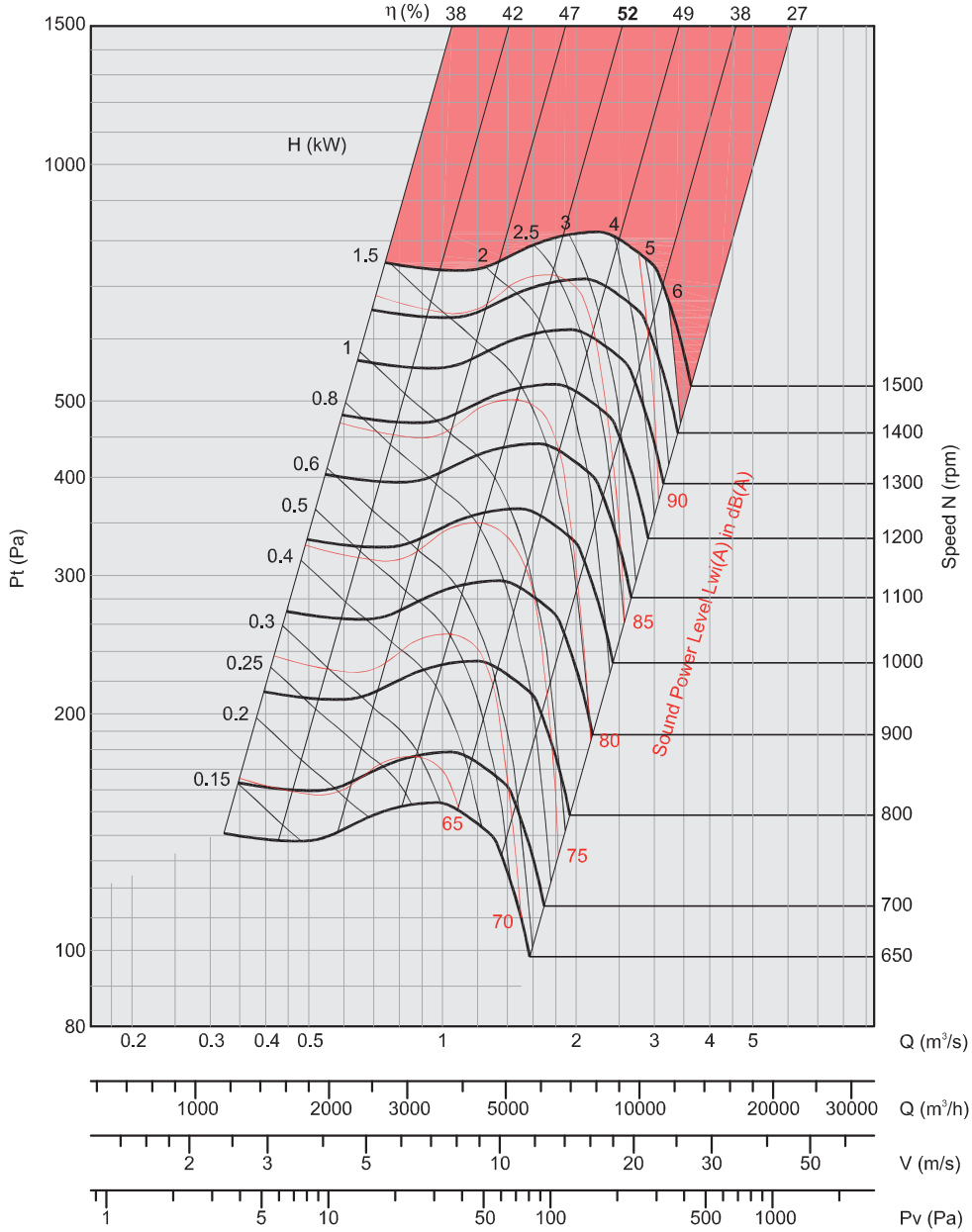

- Performance certified is for installation type B - Free inlet, Ducted outlet. Power rating kW does not include transmission losses. Performance ratings do not include the effects of appurtenances (accessories).
 - The A-weighted sound ratings shown have been calculated per AMCA International Standard 301. Values shown are for inlet LwA sound power levels for installation Type B: free inlet, ducted outlet.

$$P_v = (V/1.3)^2$$

Air performances measured according to EN ISO 5801 / AMCA 210 standard with air density with 1.2 kg/m³ specific weight. Power supply 220-240V/1Ph/50Hz or 380-420V/3Ph/50Hz.

Lp: Sound pressure level measured in free field conditions, propagation hemispherical, measurement category C in accordance with EN ISO 13349, at the point of maximum efficiency, at a distance of 1,5 meters (for comparative purposes only).
Lw: Sound power level obtained in accordance with EN ISO 3746. Tolerance +/- 3 dB(A).

BOX-T 15-15

FEG 60

ρ: 1.2kg/m³

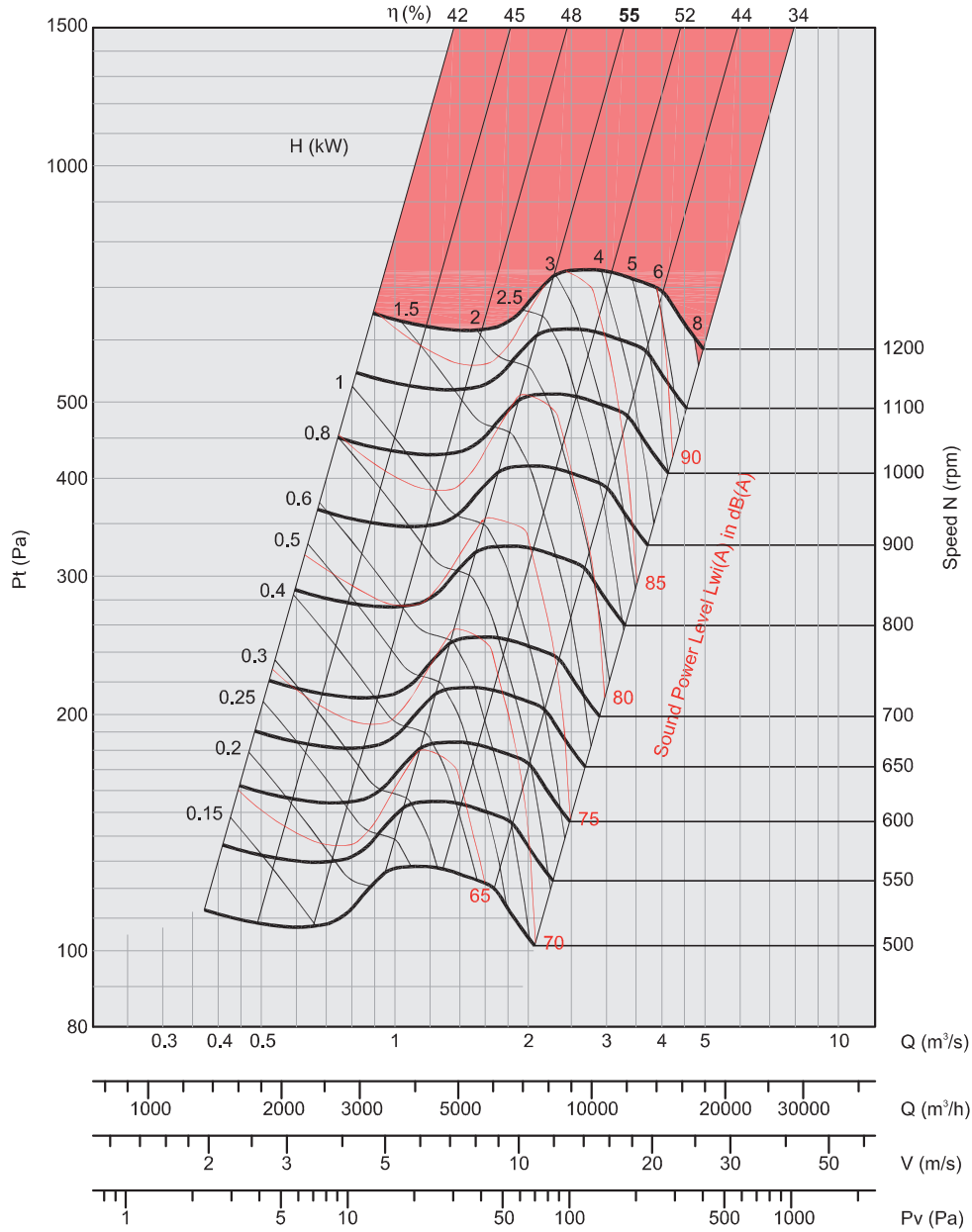

- Performance certified is for installation type B - Free inlet, Ducted outlet. Power rating kW does not include transmission losses. Performance ratings do not include the effects of appurtenances (accessories).
- The A-weighted sound ratings shown have been calculated per AMCA International Standard 301. Values shown are for inlet Lw(A) sound power levels for installation Type B: free inlet, ducted outlet.

$$Pv = (V/1.3)^2$$

Air performances measured according to EN ISO 5801 / AMCA 210 standard with air density with 1.2 kg/m³ specific weight. Power supply 220-240V/1Ph/50Hz or 380-420V/3Ph/50Hz.

Lp: Sound pressure level measured in free field conditions, propagation hemispherical, measurement category C in accordance with EN ISO 13349, at the point of maximum efficiency, at a distance of 1.5 meters (for comparative purposes only).
Lw: Sound power level obtained in accordance with EN ISO 3746. Tolerance +/- 3 dB(A).

BOX-T 18-13

FEG 67

ρ: 1.2kg/m³

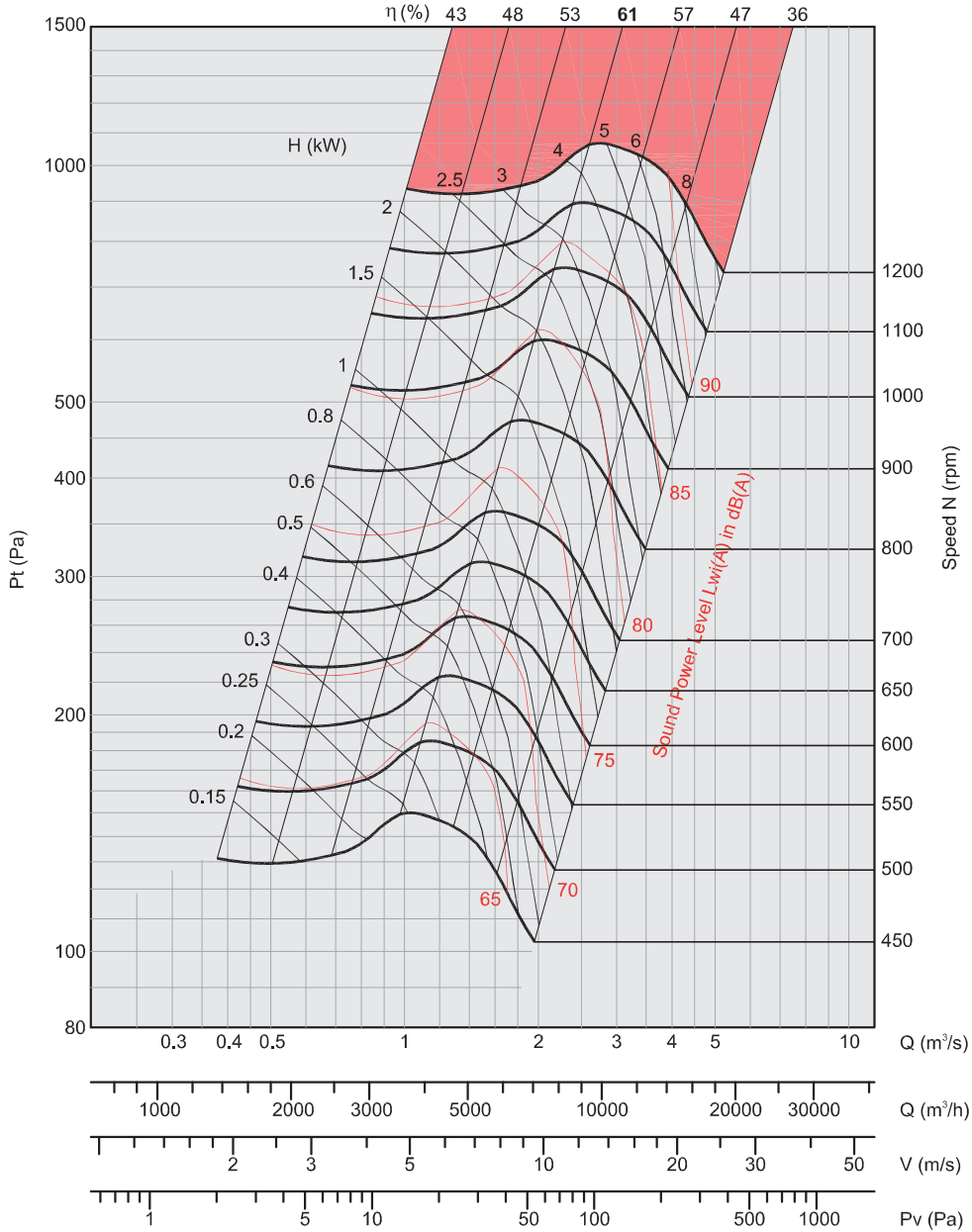

- Performance certified is for installation type B - Free inlet, Ducted outlet. Power rating kW does not include transmission losses. Performance ratings do not include the effects of appurtenances (accessories).
 - The A-weighted sound ratings shown have been calculated per AMCA International Standard 301. Values shown are for inlet LwIA sound power levels for installation Type B: free inlet, ducted outlet.

$$P_v = (V/1.3)^2$$

Air performances measured according to EN ISO 5801 / AMCA 210 standard with air density with 1.2 kg/m³ specific weight. Power supply 220-240V/1Ph/50Hz or 380-420V/3Ph/50Hz.

Lp: Sound pressure level measured in free field conditions, propagation hemispherical, measurement category C in accordance with EN ISO 13349, at the point of maximum efficiency, at a distance of 1.5 meters (for comparative purposes only).
Lw: Sound power level obtained in accordance with EN ISO 3746. Tolerance +/- 3 dB(A).

BOX-T 18-18

FEG 63

ρ: 1.2kg/m³

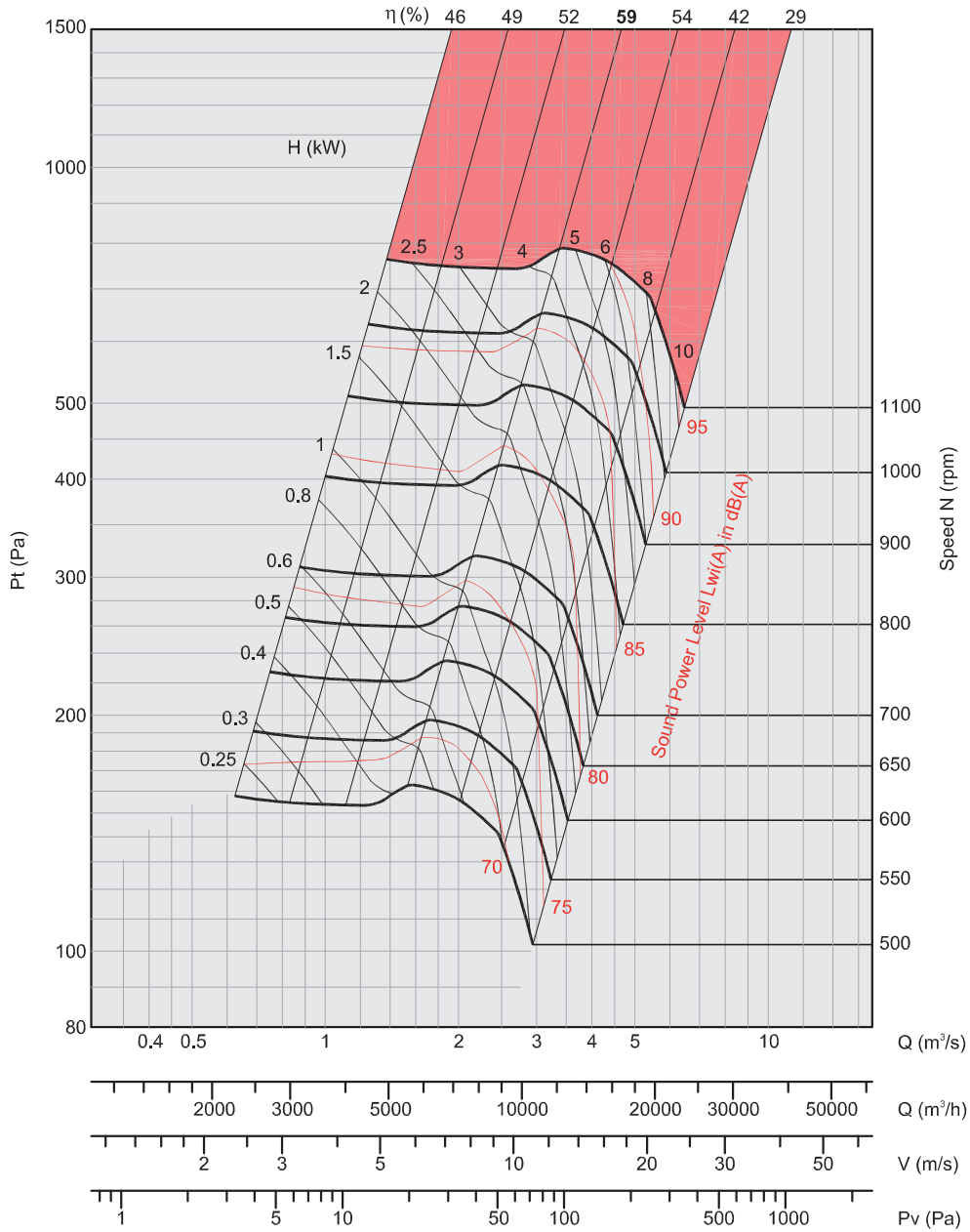

- Performance certified is for installation type B - Free inlet, Ducted outlet. Power rating kW does not include transmission losses. Performance ratings do not include the effects of appurtenances (accessories).
 - The A-weighted sound ratings shown have been calculated per AMCA International Standard 301. Values shown are for inlet LwA sound power levels for installation Type B: free inlet, ducted outlet.

$$Pv = (V/1.3)^2$$

Air performances measured according to EN ISO 5801 / AMCA 210 standard with air density with 1.2 kg/m³ specific weight. Power supply 220-240V/1Ph/50Hz or 380-420V/3Ph/50Hz.

Lp: Sound pressure level measured in free field conditions, propagation hemispherical, measurement category C in accordance with EN ISO 13349, at the point of maximum efficiency, at a distance of 1,5 meters (for comparative purposes only).
Lw: Sound power level obtained in accordance with EN ISO 3746. Tolerance +/- 3 dB(A).

BOX-T 200

FEG 60

ρ: 1.2kg/m³

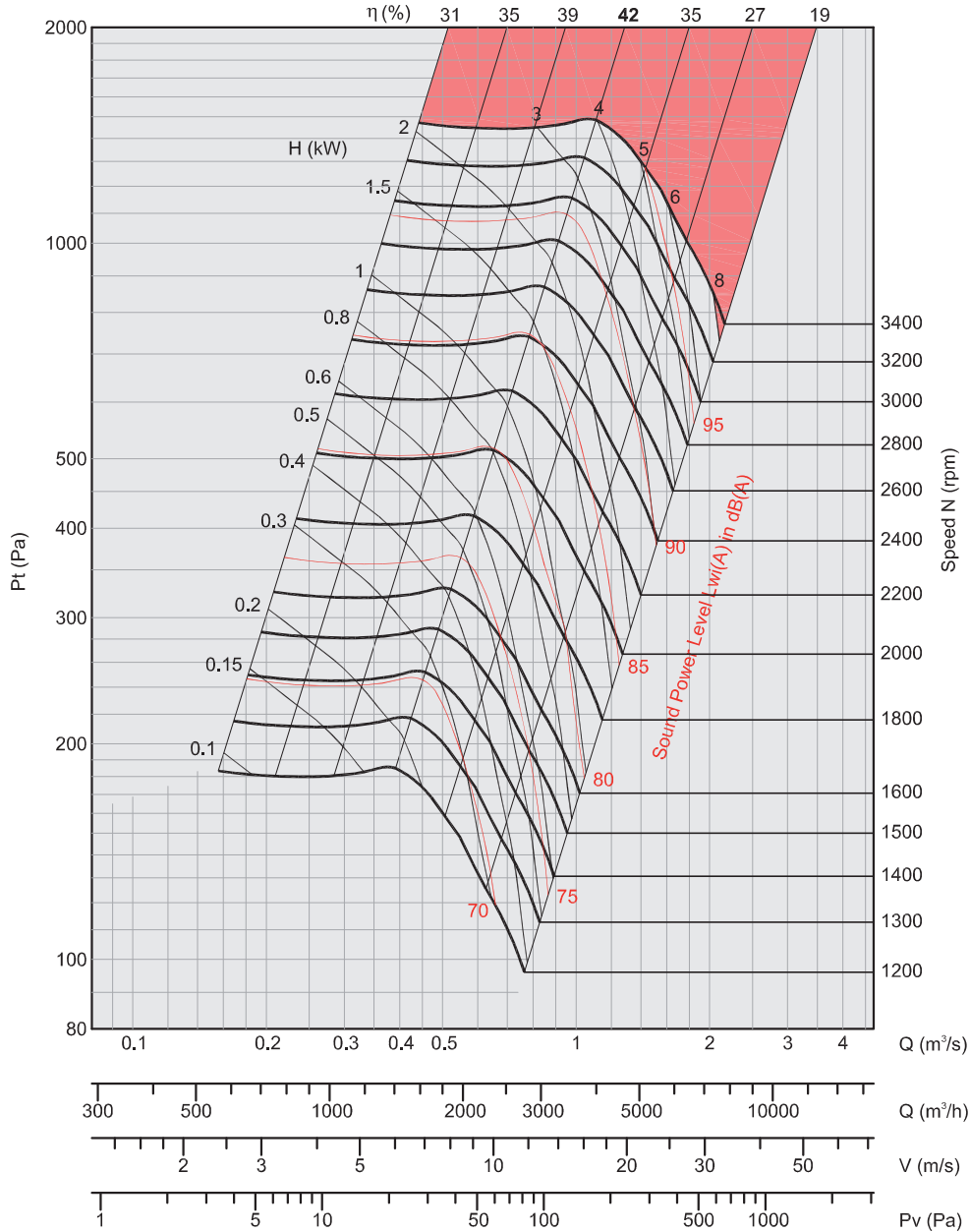

- Performance certified is for installation type B - Free Inlet, Ducted outlet, Power rating kW does not include transmission losses. Performance ratings do not include the effects of appurtenances (accessories).
 - The A-weighted sound ratings shown have been calculated per AMCA International Standard 301. Values shown are for inlet Lw/A sound power levels for installation Type B: free inlet, ducted outlet.

$$Pv = (V/1.3)^2$$

Air performances measured according to EN ISO 5801 / AMCA 210 standard with air density with 1.2 kg/m³ specific weight. Power supply 220-240V/1Ph/50Hz or 380-420V/3Ph/50Hz.

Lp: Sound pressure level measured in free field conditions, propagation hemispherical, measurement category C in accordance with EN ISO 13349, at the point of maximum efficiency, at a distance of 1.5 meters (for comparative purposes only).
Lw: Sound power level obtained in accordance with EN ISO 3746. Tolerance +/- 3 dB(A).

BOX-T 225

FEG 60

ρ: 1.2kg/m³

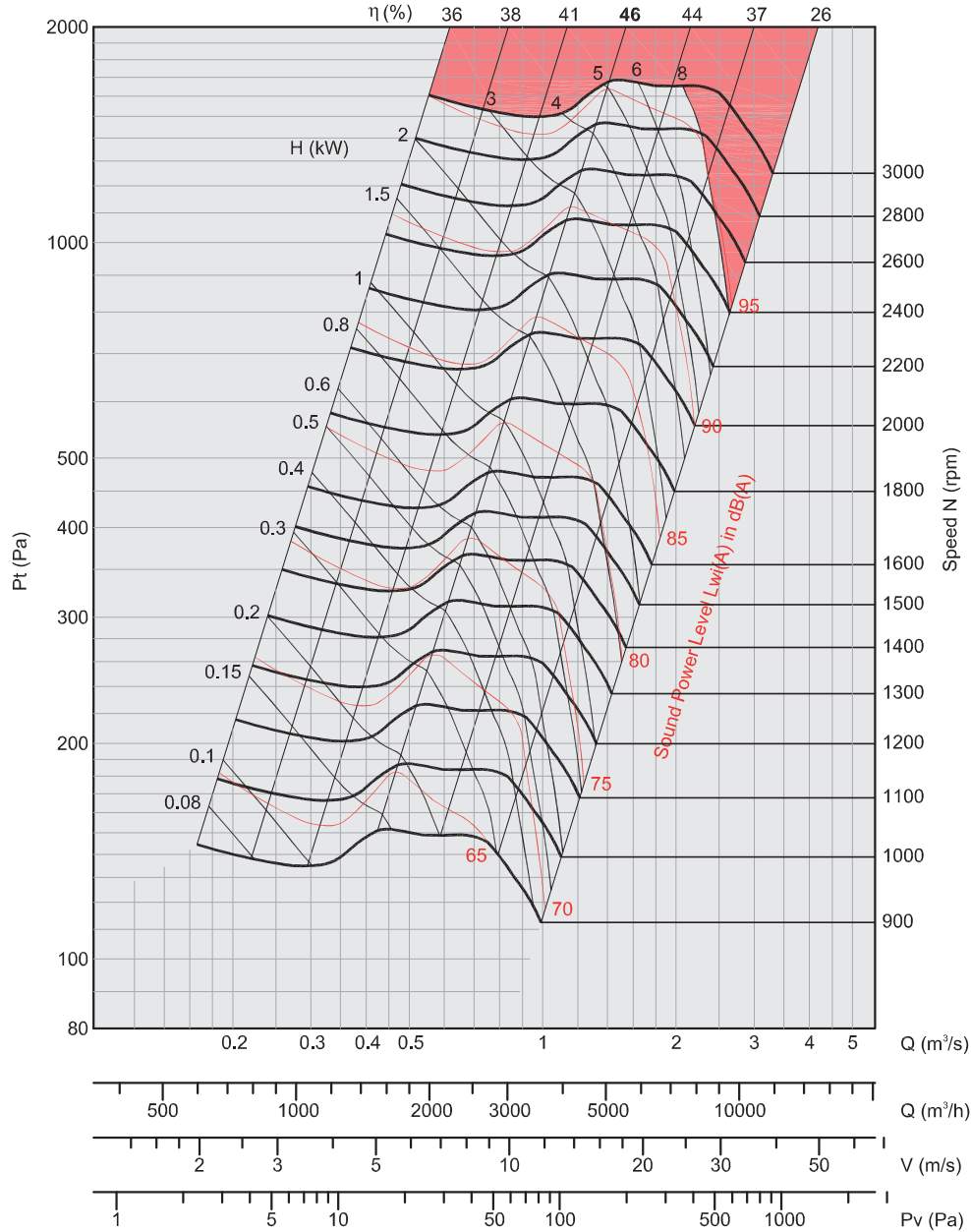

- Performance certified is for installation type B - Free inlet, Ducted outlet. Power rating kW does not include transmission losses. Performance ratings do not include the effects of appurtenances (accessories).
- The A-weighted sound ratings shown have been calculated per AMCA International Standard 301. Values shown are for inlet LwA sound power levels for installation Type B: free inlet, ducted outlet.

$$P_v = (V/1.3)^2$$

Air performances measured according to EN ISO 5801 / AMCA 210 standard with air density with 1.2 kg/m³ specific weight. Power supply 220-240V/1Ph/50Hz or 380-420V/3Ph/50Hz.

Lp: Sound pressure level measured in free field conditions, propagation hemispherical, measurement category C in accordance with EN ISO 13349, at the point of maximum efficiency, at a distance of 1,5 meters (for comparative purposes only).
Lw: Sound power level obtained in accordance with EN ISO 3746. Tolerance +/- 3 dB(A).

BOX-T 250

FEG 63

ρ: 1.2kg/m³

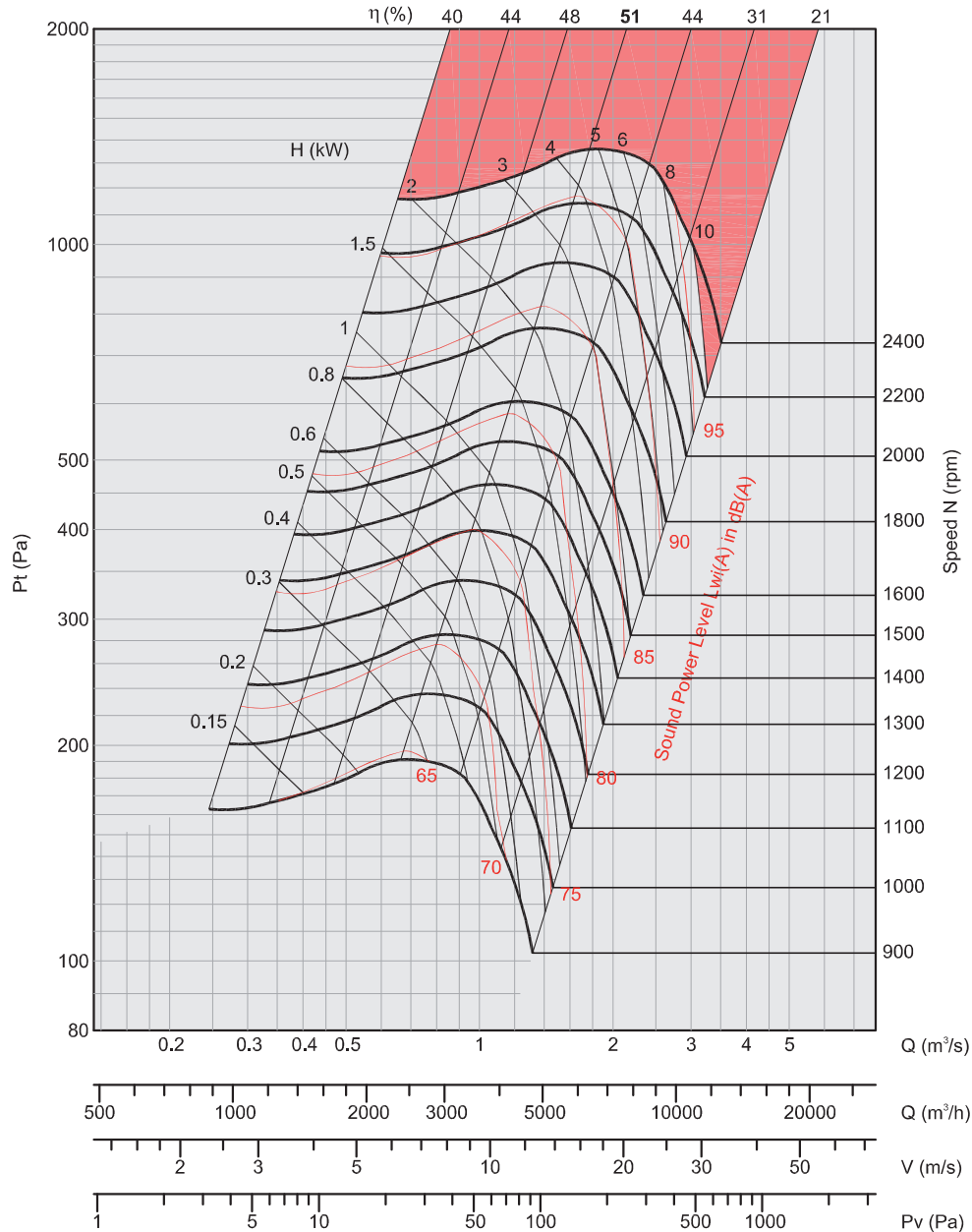

- Performance certified is for installation type B - Free inlet, Ducted outlet. Power rating kW does not include transmission losses. Performance ratings do not include the effects of appurtenances (accessories).
 - The A-weighted sound ratings shown have been calculated per AMCA International Standard 301. Values shown are for inlet Lw/A sound power levels for installation Type B: free inlet, ducted outlet.

$$P_v = (V/1.3)^2$$

Air performances measured according to EN ISO 5801 / AMCA 210 standard with air density with 1.2 kg/m³ specific weight. Power supply 220-240V/1Ph/50Hz or 380-420V/3Ph/50Hz.

Lp: Sound pressure level measured in free field conditions, propagation hemispherical, measurement category C in accordance with EN ISO 13349, at the point of maximum efficiency, at a distance of 1.5 meters (for comparative purposes only).
Lw: Sound power level obtained in accordance with EN ISO 3746. Tolerance +/- 3 dB(A).

BOX-T 280

FEG 53

ρ: 1.2kg/m³

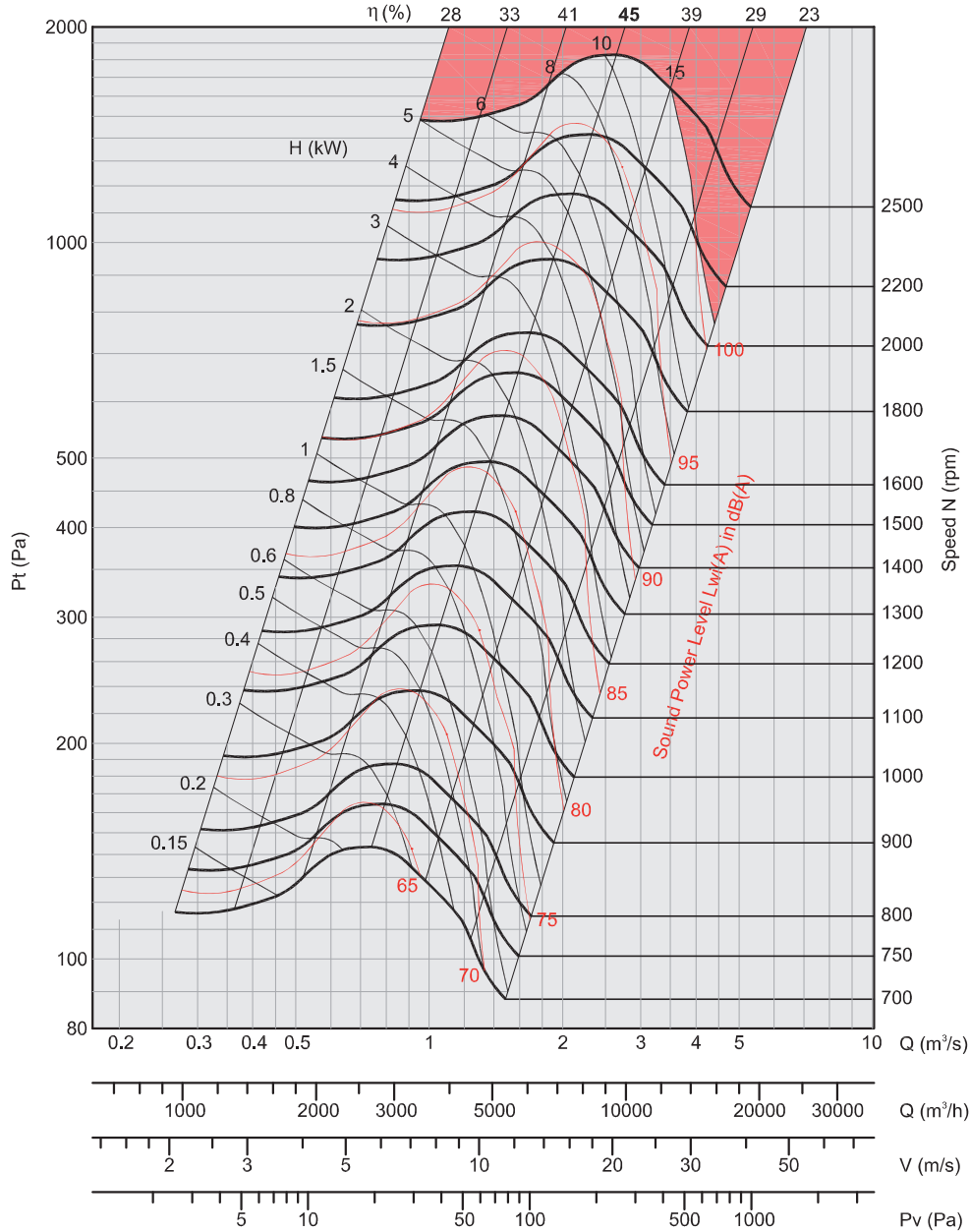

- Performance certified is for installation type B - Free inlet, Ducted outlet. Power rating kW does not include transmission losses. Performance ratings do not include the effects of appurtenances (accessories).
- The A-weighted sound ratings shown have been calculated per AMCA International Standard 301. Values shown are for inlet LwA sound power levels for installation Type B: free inlet, ducted outlet.

$P_v = (V/1.3)^2$

Air performances measured according to EN ISO 5801 / AMCA 210 standard with air density with 1.2 kg/m³ specific weight. Power supply 220-240V/1Ph/50Hz or 380-420V/3Ph/50Hz.

Lp: Sound pressure level measured in free field conditions, propagation hemispherical, measurement category C in accordance with EN ISO 13349, at the point of maximum efficiency, at a distance of 1,5 meters (for comparative purposes only).
Lw: Sound power level obtained in accordance with EN ISO 3746. Tolerance +/- 3 dB(A).

BOX-T 315

FEG 67

ρ: 1.2kg/m³

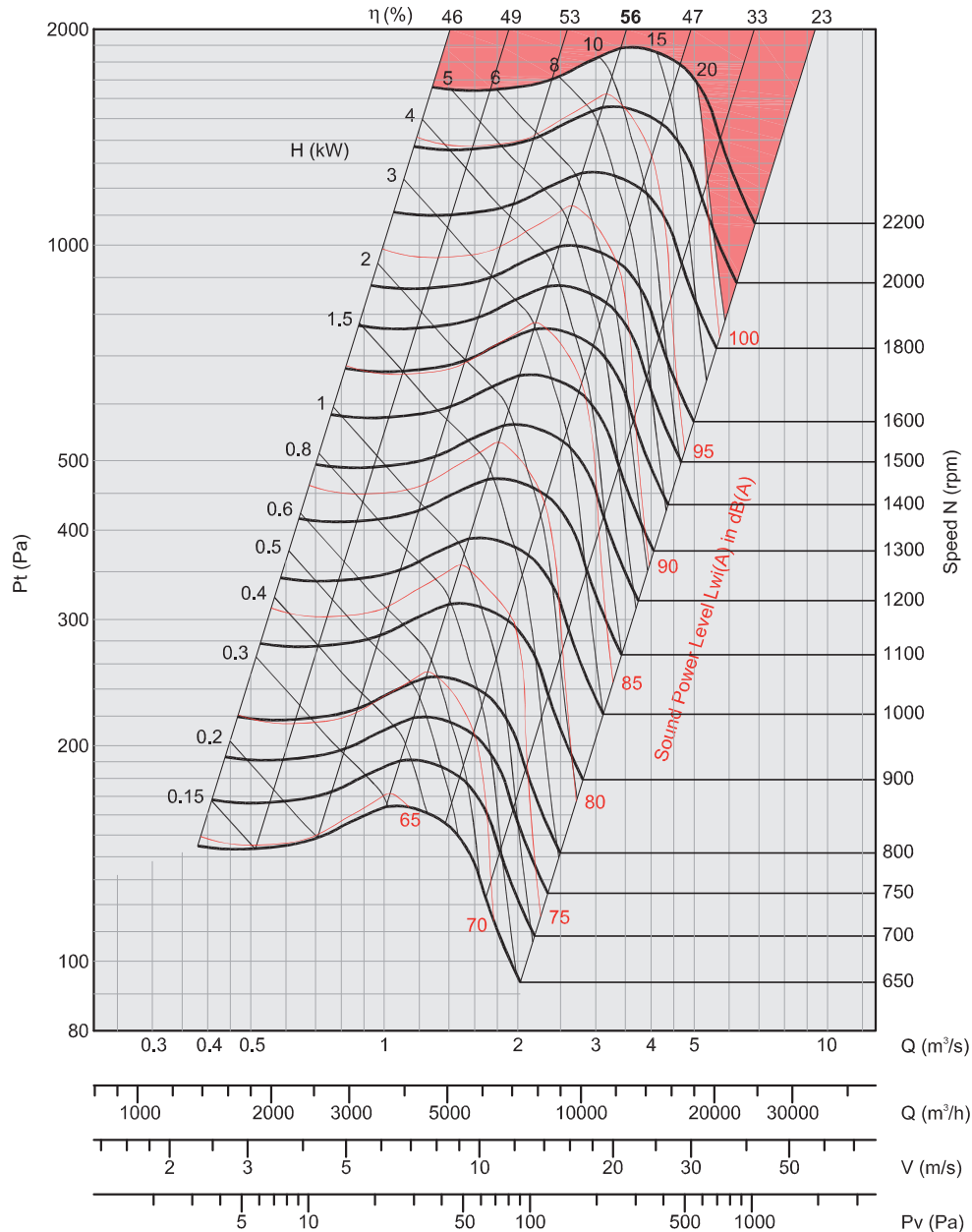

- Performance certified is for installation type B - Free inlet, Ducted outlet. Power rating kW does not include transmission losses. Performance ratings do not include the effects of appurtenances (accessories).
 - The A-weighted sound ratings shown have been calculated per AMCA International Standard 301. Values shown are for inlet Lw(A) sound power levels for installation Type B: free inlet, ducted outlet.

$$P_v = (V/1.3)^2$$

Air performances measured according to EN ISO 5801 / AMCA 210 standard with air density with 1.2 kg/m³ specific weight. Power supply 220-240V/1Ph/50Hz or 380-420V/3Ph/50Hz.

Lp: Sound pressure level measured in free field conditions, propagation hemispherical, measurement category C in accordance with EN ISO 13349, at the point of maximum efficiency, at a distance of 1.5 meters (for comparative purposes only).
Lw: Sound power level obtained in accordance with EN ISO 3746. Tolerance +/- 3 dB(A).

BOX-T 355

FEG 63

ρ: 1.2kg/m³

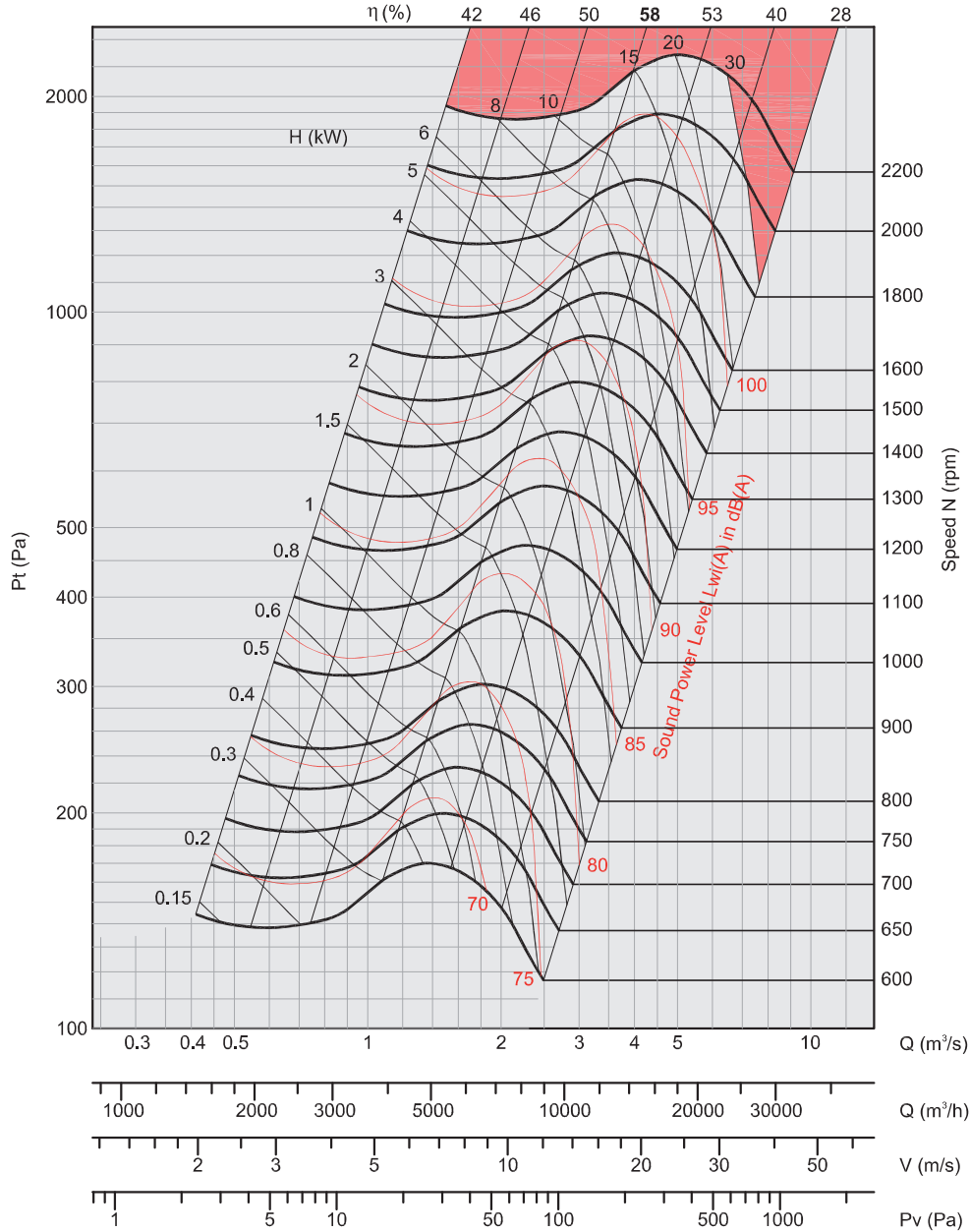

- Performance certified is for installation type B - Free inlet, Ducted outlet. Power rating kW does not include transmission losses. Performance ratings do not include the effects of appurtenances (accessories).
- The A-weighted sound ratings shown have been calculated per AMCA International Standard 301. Values shown are for inlet LwA sound power levels for installation Type B: free inlet, ducted outlet.

$$P_v = (V/1.3)^2$$

Air performances measured according to EN ISO 5801 / AMCA 210 standard with air density with 1.2 kg/m³ specific weight. Power supply 220-240V/1Ph/50Hz or 380-420V/3Ph/50Hz.

Lp: Sound pressure level measured in free field conditions, propagation hemispherical, measurement category C in accordance with EN ISO 13349, at the point of maximum efficiency, at a distance of 1,5 meters (for comparative purposes only).
Lw: Sound power level obtained in accordance with EN ISO 3746. Tolerance +/- 3 dB(A).

BOX-T 400

FEG 63

ρ: 1.2kg/m³

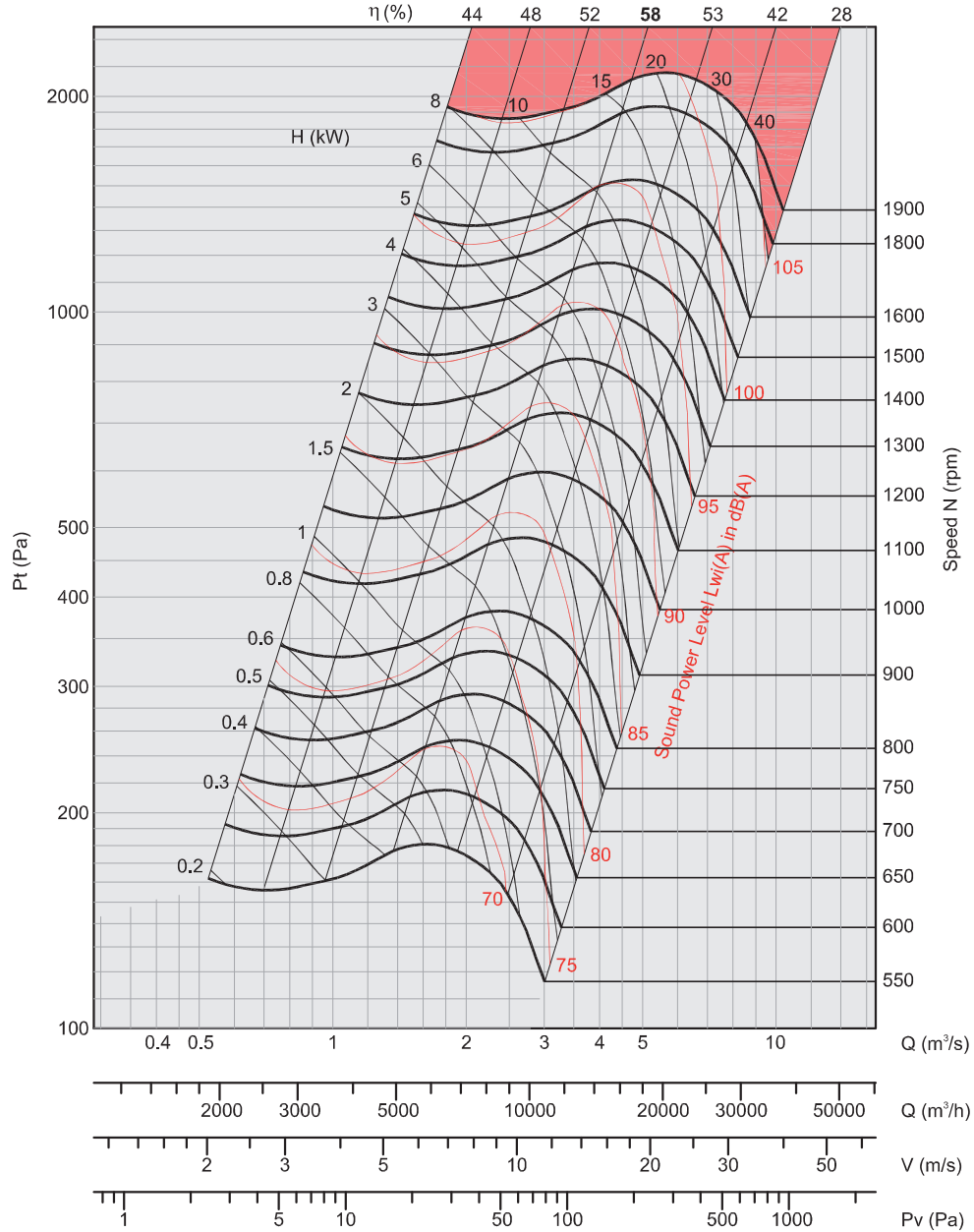

- Performance certified is for installation type B - Free inlet, Ducted outlet. Power rating kW does not include transmission losses. Performance ratings do not include the effects of appurtenances (accessories).
- The A-weighted sound ratings shown have been calculated per AMCA International Standard 301. Values shown are for inlet LwA sound power levels for installation Type B: free inlet, ducted outlet.

$$P_v = (V/1.3)^2$$

Air performances measured according to EN ISO 5801 / AMCA 210 standard with air density with 1.2 kg/m³ specific weight. Power supply 220-240V/1Ph/50Hz or 380-420V/3Ph/50Hz.

Lp: Sound pressure level measured in free field conditions, propagation hemispherical, measurement category C in accordance with EN ISO 13349, at the point of maximum efficiency, at a distance of 1.5 meters (for comparative purposes only).
Lw: Sound power level obtained in accordance with EN ISO 3746. Tolerance +/- 3 dB(A).

BOX-T 450

FEG 63

ρ: 1.2kg/m³

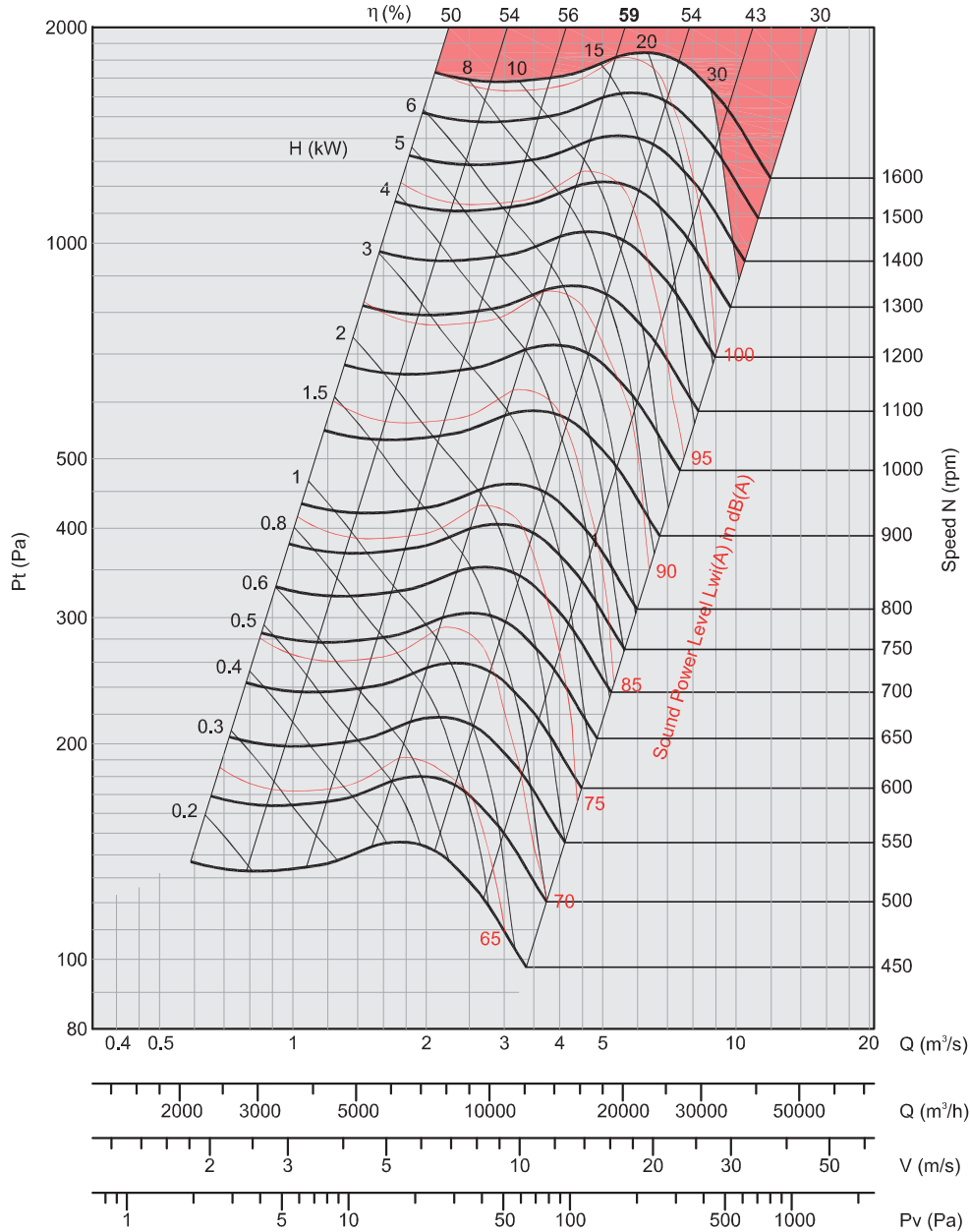

- Performance certified is for installation type B - Free inlet, Ducted outlet. Power rating kW does not include transmission losses. Performance ratings do not include the effects of appurtenances (accessories).
 - The A-weighted sound ratings shown have been calculated per AMCA International Standard 301. Values shown are for inlet LwA sound power levels for installation Type B: free inlet, ducted outlet.

$$Pv = (V/1.3)^2$$

Air performances measured according to EN ISO 5801 / AMCA 210 standard with air density with 1.2 kg/m³ specific weight.
 Power supply 220-240V/1Ph/50Hz or 380-420V/3Ph/50Hz.

Lp: Sound pressure level measured in free field conditions, propagation hemispherical, measurement category C in accordance with EN ISO 13349, at the point of maximum efficiency, at a distance of 1,5 meters (for comparative purposes only).
Lw: Sound power level obtained in accordance with EN ISO 3746. Tolerance +/- 3 dB(A).

BOX-T 500

FEG 60

ρ: 1.2kg/m³

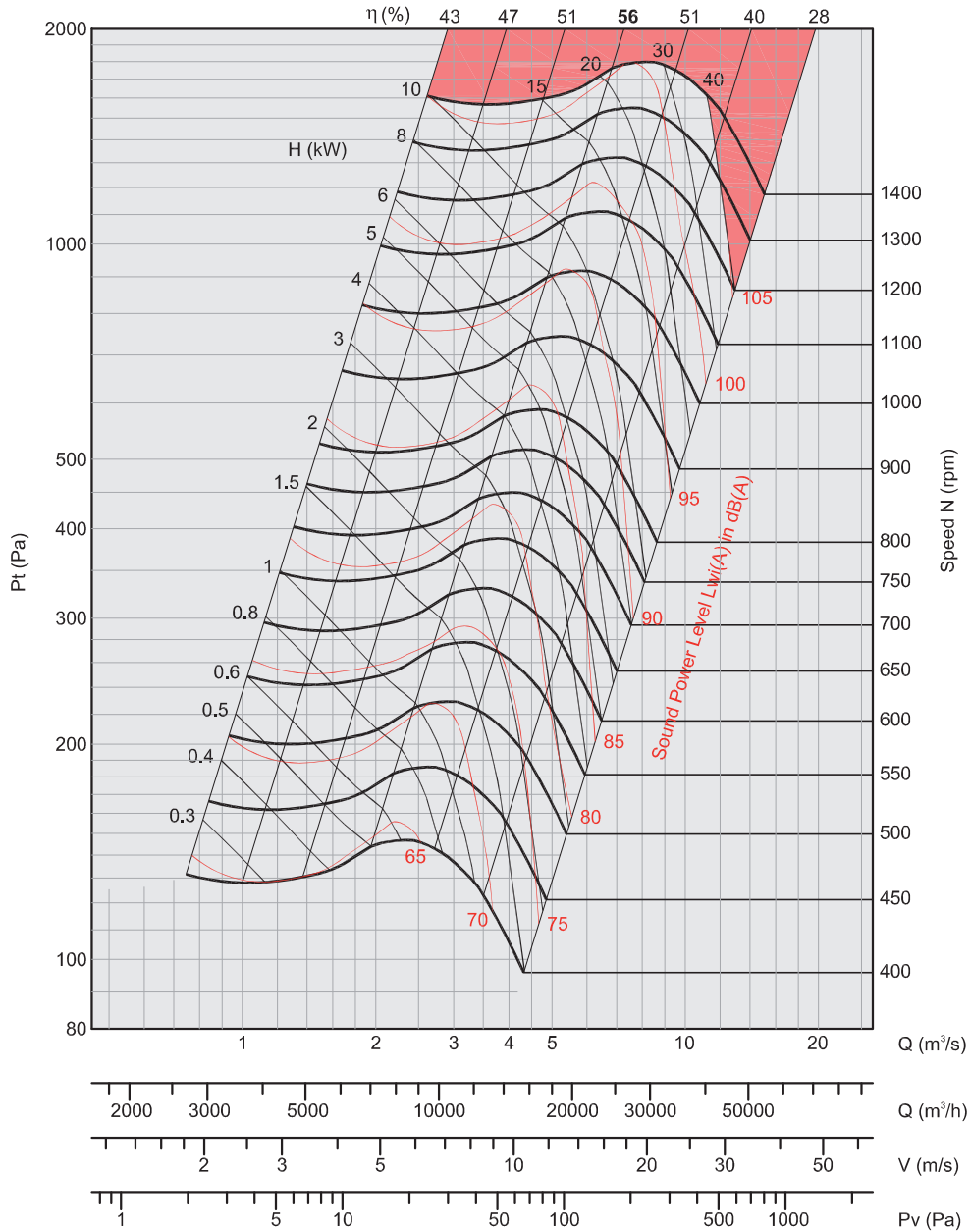

- Performance certified is for installation type B - Free inlet, Ducted outlet. Power rating kW does not include transmission losses. Performance ratings do not include the effects of appurtenances (accessories).
 - The A-weighted sound ratings shown have been calculated per AMCA International Standard 301. Values shown are for inlet LwA sound power levels for installation Type B: free inlet, ducted outlet.

$$P_v = (V/1.3)^2$$

Air performances measured according to EN ISO 5801 / AMCA 210 standard with air density with 1.2 kg/m³ specific weight. Power supply 220-240V/1Ph/50Hz or 380-420V/3Ph/50Hz.

Lp: Sound pressure level measured in free field conditions, propagation hemispherical, measurement category C in accordance with EN ISO 13349, at the point of maximum efficiency, at a distance of 1.5 meters (for comparative purposes only).
Lw: Sound power level obtained in accordance with EN ISO 3746. Tolerance +/- 3 dB(A).

BOX-T 560

FEG 60

ρ: 1.2kg/m³

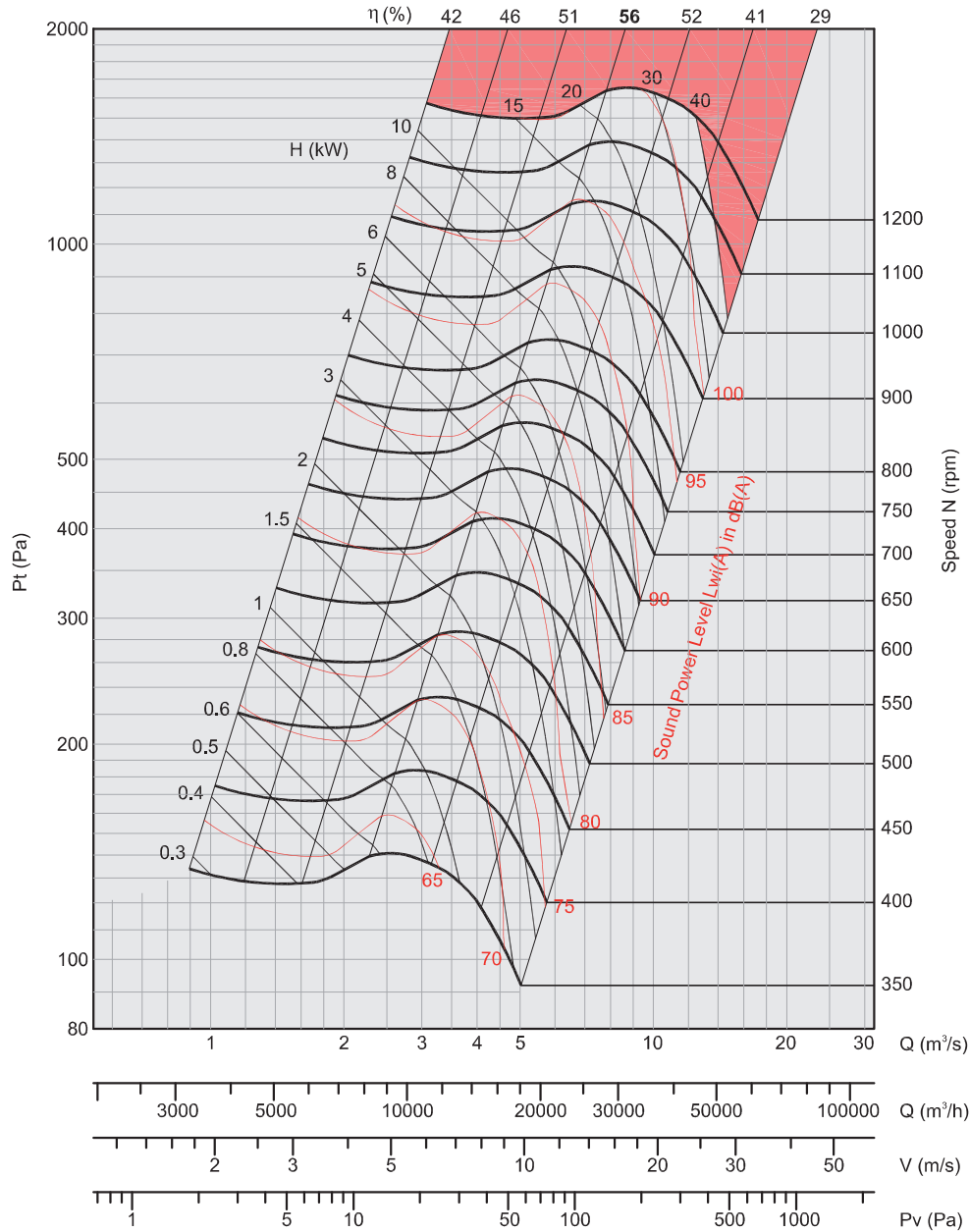

- Performance certified is for installation type B - Free inlet, Ducted outlet. Power rating kW does not include transmission losses. Performance ratings do not include the effects of appurtenances (accessories).
- The A-weighted sound ratings shown have been calculated per AMCA International Standard 301. Values shown are for inlet LwA sound power levels for installation Type B: free inlet, ducted outlet.

$$P_v = (V/1.3)^2$$

Air performances measured according to EN ISO 5801 / AMCA 210 standard with air density with 1.2 kg/m³ specific weight. Power supply 220-240V/1Ph/50Hz or 380-420V/3Ph/50Hz.

Lp: Sound pressure level measured in free field conditions, propagation hemispherical, measurement category C in accordance with EN ISO 13349, at the point of maximum efficiency, at a distance of 1,5 meters (for comparative purposes only).
Lw: Sound power level obtained in accordance with EN ISO 3746. Tolerance +/- 3 dB(A).

BOX-T 630

FEG 63

ρ: 1.2kg/m³

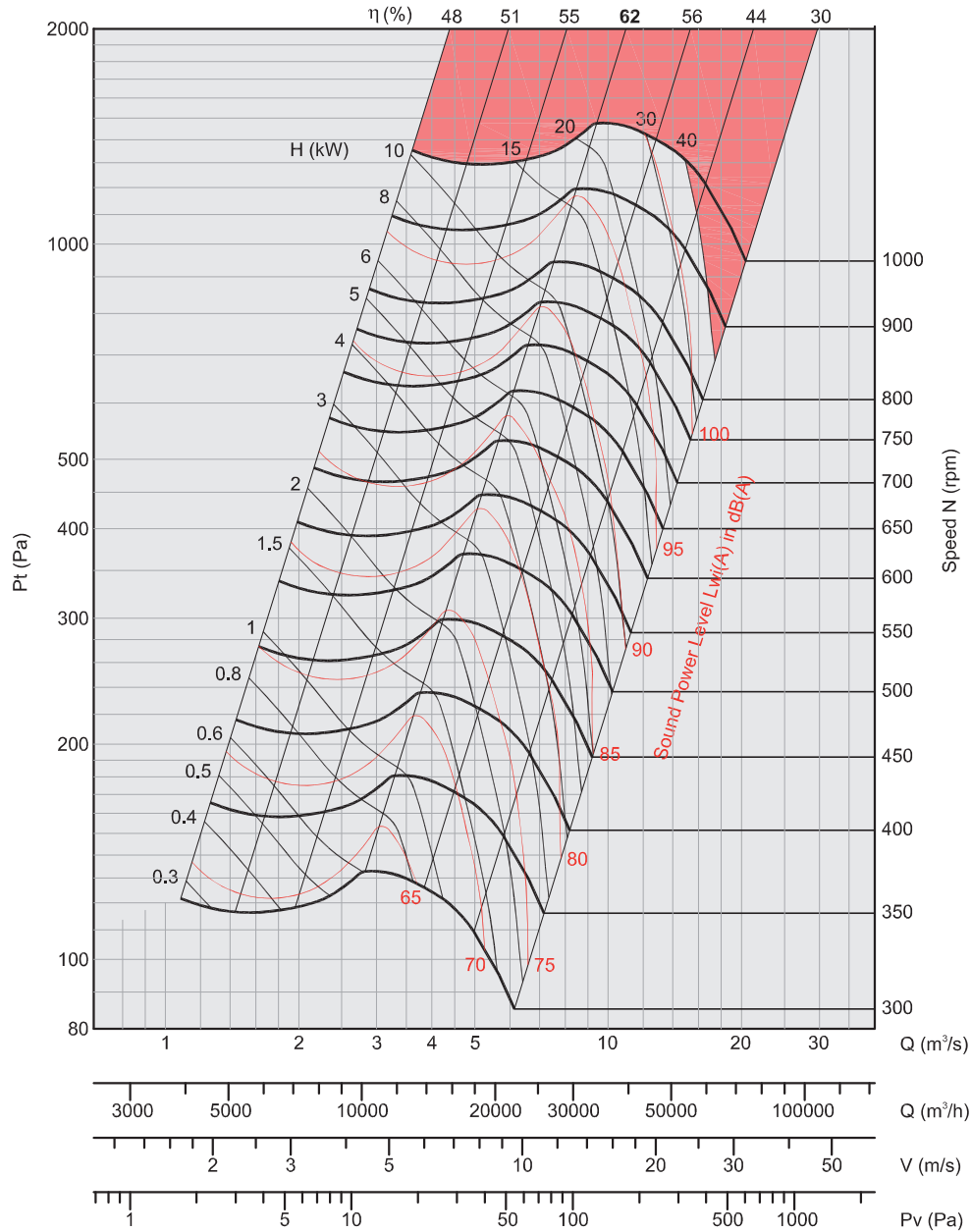

- Performance certified is for installation type B - Free inlet, Ducted outlet. Power rating kW does not include transmission losses. Performance ratings do not include the effects of appurtenances (accessories).
 - The A-weighted sound ratings shown have been calculated per AMCA International Standard 301. Values shown are for inlet LwA sound power levels for installation Type B: free inlet, ducted outlet.

$$P_v = (V/1.3)^2$$

All dimensions in mm. 2. Weight with Fan, Std. motor as per below motor frame size & Std. drive set these dimensions are without any accessories 3. Any Non-standard sizes with different accessories. weight please consult with your local representative. 4. Dynair reserve the right, while leaving the essential characteristics the same, to modify the data, photograph and anything else shown in the above without prior warning.

BOX-T 7-7 to 12-12

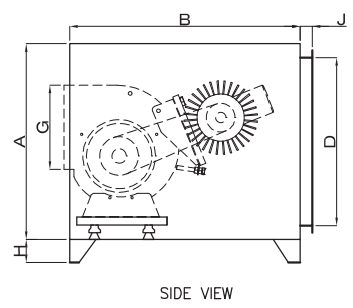
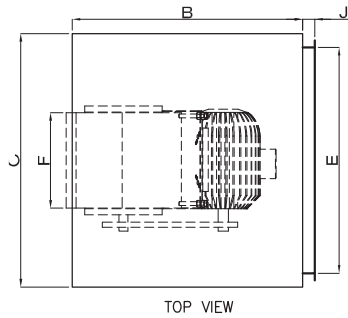

Model	A	B	C	D	E	F	G	H	J	Max. Motor Frame Size	Approx. Total Weight (Kg)
7-7	550	680	600	470	520	259	228	100	40	90	67
9-7	650	750	650	570	570	232	262			112	85
9-9	650	750	650	570	570	298	262			112	87
10-8	700	850	650	620	570	265	289			112	91
10-10	700	850	650	620	570	331	289			112	96
12-9	750	875	750	670	670	309	341			132	120
12-12	750	875	750	670	670	395	341			132	124

BOX-T 15-15 to 18-18

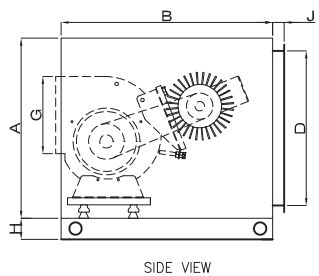
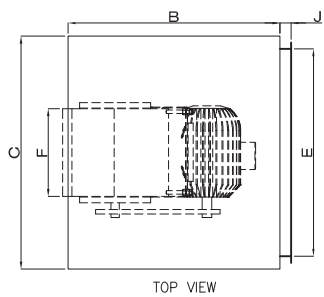

Model	A	B	C	D	E	F	G	H	J	Max. Motor Frame Size	Approx. Total Weight (Kg)
15-15	900	1050	900	820	820	471	404	100	40	132	212
18-13	1100	1150	1100	1020	1020	430	478			160	277
18-18	1100	1150	1100	1020	1020	557	478			160	302

All dimensions in mm. 2. Weight with Fan, Std. motor as per below motor frame size & Std. drive set these dimensions are without any accessories 3. Any Non-standard sizes with different accessories. weight please consult with your local representative. 4. Dynair reserve the right, while leaving the essential characteristics the same, to modify the data, photograph and anything else shown in the above without prior warning.

BOX-T 200 to 400

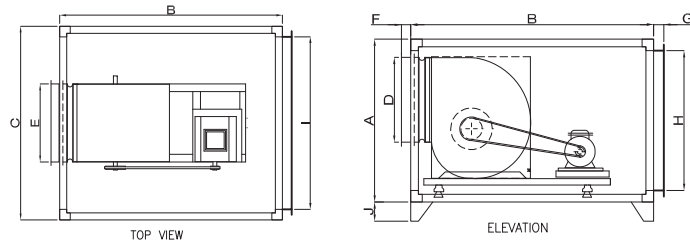

Model	A	B	C	D	E	F	G	H	I	J	Max. Motor Frame Size	Approx. Total Weight (Kg)
200	600	750	600	255	255	70	70	500	500	100	80	105
225	650	950	650	290	290	70	70	550	550	100	90	125
250	700	1000	700	325	325	70	70	600	600	100	90	135
280	800	1050	800	360	360	70	70	700	700	100	160	175
315	850	1200	900	405	405	70	70	725	775	100	160	210
355	950	1250	1000	455	455	70	70	825	875	100	180	235
400	1000	1300	1100	510	510	70	70	875	975	100	180	310

With extruded AL profile

BOX-T 450 to 630

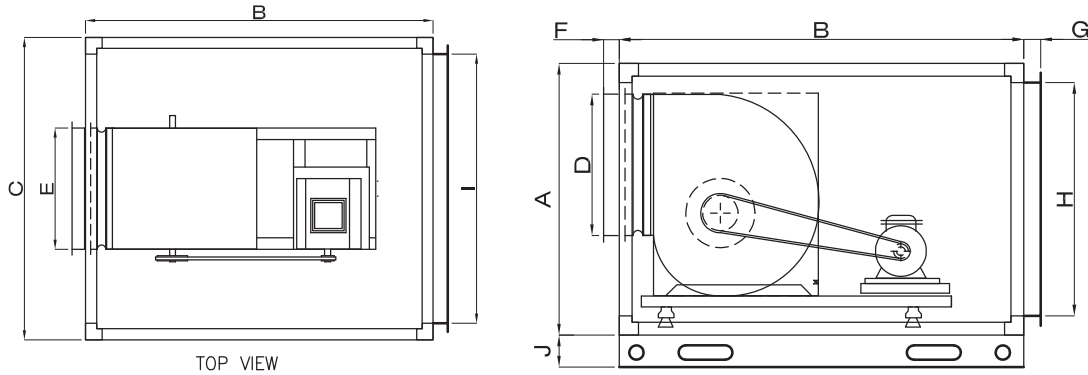

Model	A	B	C	D	E	F	G	H	I	J	Max. Motor Frame Size	Approx. Total Weight (Kg)
450	1200	1400	1200	570	570	70	70	1075	1075	100	200	355
500	1200	1400	1200	640	640	70	70	1075	1075	100	200	404
560	1300	1650	1350	715	715	70	70	1175	1225	100	200	477
630	1450	1760	1500	800	800	70	70	1325	1375	100	200	602

With extruded AL profile

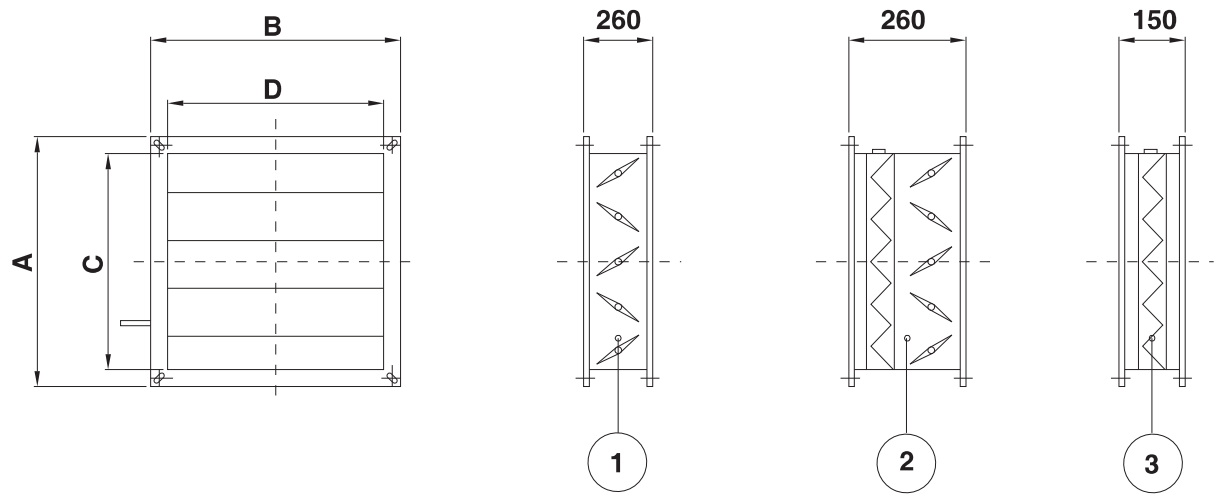

Type	A	B	C	D
7/7	382	517	385	495
9/9	447	567	445	535
10/10	497	567	495	535
12/12	577	617	584	585
15/15	677	817	645	755
18/18	817	1017	775	955
500	987	1117	965	1055
560	1110	1270	1075	1205
630	1230	1420	1205	1355

Dimensions in mm

- ① SETTING SHUTTER
- ② SETTING SHUTTER WITH FILTERING SECTION
- ③ FILTERING SECTION